

Hotpoint MW33N/H

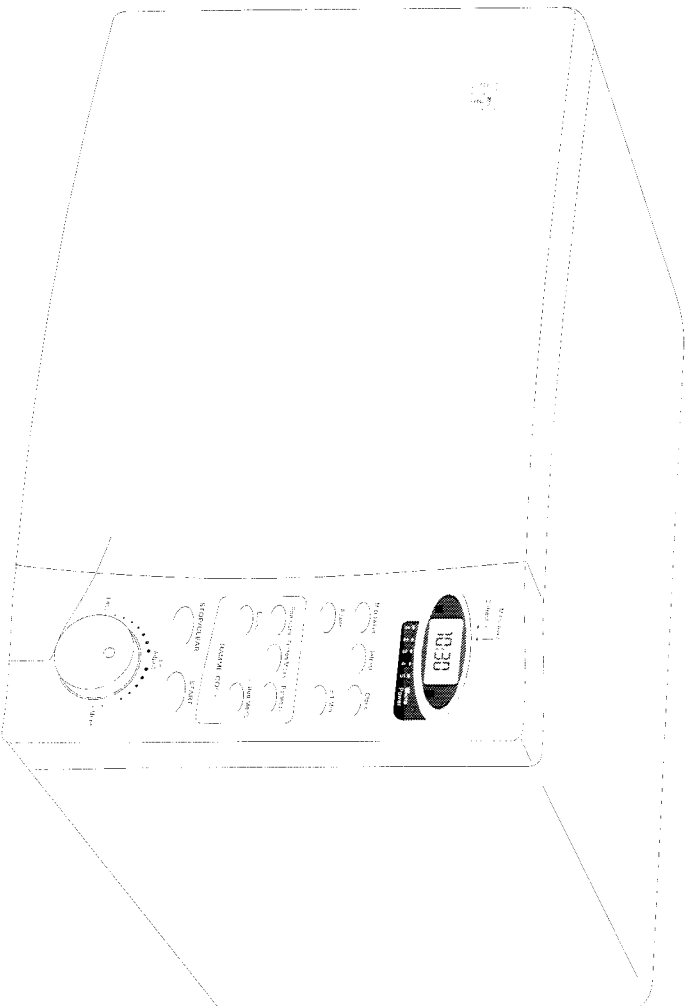

Cooking with your microwave

Instruction booklet

Hotpoint
Cannon  **Creda**

USERS HANDBOOK MW33

Batch X2030X



530MW33

In the interest of consumer safety this part should only be fitted by a suitably qualified person with the machine disconnected from the mains supply.

Safety

Smoke and fire

In the event of smoke or fire, switch off the oven and leave the door closed to contain any flames.

Carefully follow cooking instructions for food with a high sugar or fat content, such as Christmas pudding or fruit cake. The sugar or fat can overheat and in some cases catch fire. In the event of a fire, switch off the oven and leave the door closed to contain any flames.

Delayed boiling

Take extra care when handling drinks heated in the microwave. Always stir liquids before, during and after cooking, and allow them to stand before serving; they can come to the boil even after the microwave has finished heating.

Baby food and drink

Always stir or shake feeding bottles and baby food jars, and check the temperature before feeding to the baby.

Door

Do not use the oven if the door or door seals are damaged. Have the oven repaired by a qualified repairer.

Do not attempt to operate the oven while the door is open by tampering with the safety devices.

Do not let dirt or food residue build up between the front of the oven and the oven door.

Repairs and service

Do not remove any covers or attempt to carry out repairs or service. Contact a qualified repairer.

Cooking containers

Use open containers to heat food and drink. Pressure can build up in sealed containers causing them to explode.

Eggs

Do not cook eggs in their shells. Pressure can build up in the shell causing the egg to explode.

Pre-heating

You must not pre-heat the oven (i.e. without any foodstuffs in the oven) or use it without first placing some foodstuff inside it – potentially dangerous sparks can be caused when the oven is used when empty.

Contents

Unpacking and getting ready	page 4
Introducing microwave cooking	page 8
Using the microwave	page 14
Programme cooking	page 18
Automatic defrosting	page 20
Advanced features	page 22
Cleaning your microwave	page 24
Using aluminium foil in your microwave	page 25
Using your oven safely	page 26
Questions and answers	page 28
Cooking guidelines	page 30
Specification	page 39
Electrical supply	page 39

Unpacking and getting ready

This microwave oven is designed for home use. It should not be used for commercial catering.

After unpacking your oven, check that it hasn't been damaged whilst in the box. Make sure there are no dents, that the door closes properly, and that the seal is not damaged. A dented or damaged oven could allow microwave energy to escape.

Make sure that you've taken all the packaging from inside the oven.

Choose a flat work surface for your microwave away from heat sources such as radiators or fires, and away from anywhere that's very cold.

You should allow a 10cm space all around the oven so that warm air can escape from the vents during cooking – it is not designed to be built in.

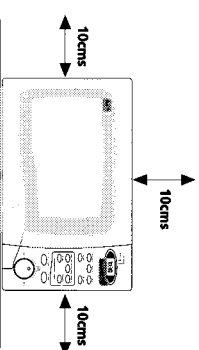

Plug your oven into a standard household electrical socket (240 volt, 13 amp rated).

Avoid using a socket that also has an adaptor and other equipment plugged in.

Slot the turntable spindle into its hole in the bottom/middle of your oven. Put the turntable ring inside the oven and place the glass turntable on top of the ring. The turntable is shaped to sit securely on the spindle.

You must always use the turntable and ring whenever you use the microwave.

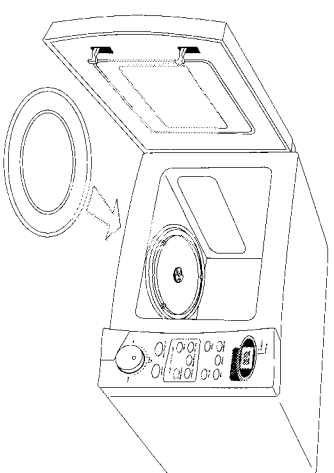

Unpacking

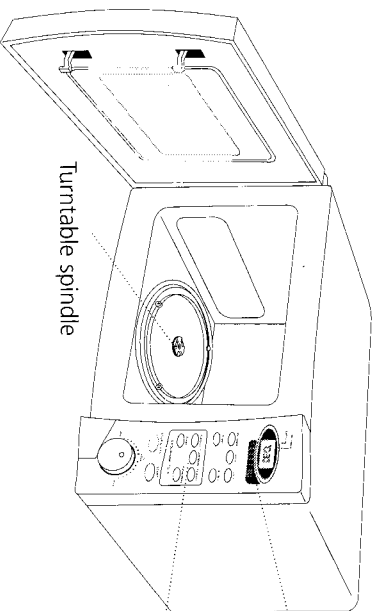

Turntable spindle

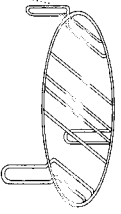

Spacer rack

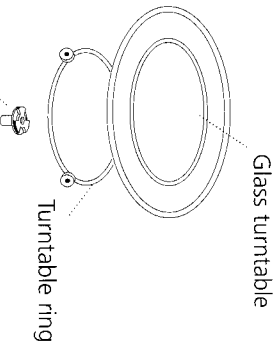

Glass turntable

Turntable ring

Turntable spindle

Display
Shows the clock, cooking power level and cooking category

Control panel
The oven beeps when you choose a setting on the control panel

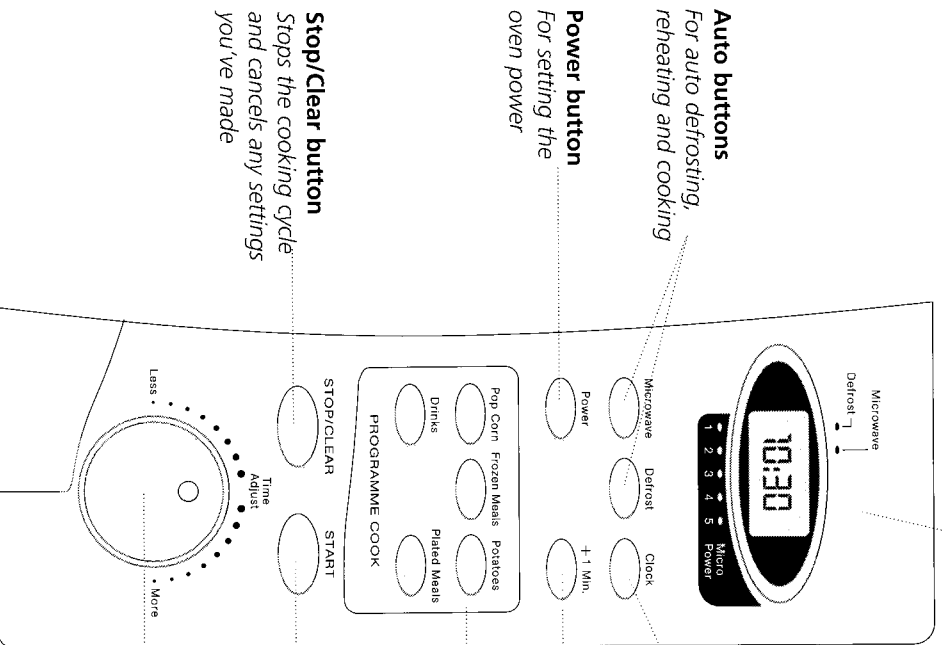

Auto buttons
For auto defrosting, reheating and cooking

Power button
For setting the oven power

Stop/Clear button
Stops the cooking cycle and cancels any settings you've made

Clock button
For setting and changing the clock

+ 1 min button
For quick start cooking

Programme cook
Selects the power and cooking time settings for you

Start button
Starts the cooking or defrosting cycle

Time adjust knob
For selecting and changing time settings

Safety

Moisture

Don't allow your oven to be exposed to rain, moisture or dust.

Care for youngsters

Take extra care to test the temperature of food or drink before giving it to babies or children.

Never allow children to play with the oven.

Service

Leave service and maintenance to qualified repairers. Don't remove any fixed covers as this could expose dangerous voltages.

Power

Your oven is supplied with an approved 13 amp fused mains plug. Always use a 13 amp (BS 1362) approved fuse.

Never use this plug without the fuse cover.

Setting the clock

Press the **clock** button once. 12:00 will flash on the hour display.



Hint

The time format of the oven is 24 hour, i.e. 3.35pm will show in the display as 15:35.

Set the desired time by turning the **time adjust** knob anti-clockwise (less), backwards in time, and clockwise (more), forwards in time. When the display shows the correct hour, press **clock**.



Hint

It is possible to display the current time whilst cooking. Press the **clock** button, the current time will flash for 3 seconds, after which time it will return to the cooking cycle time.



Hint

Whenever you unplug the microwave, or there is a powercut the clock will flash the display 12:00.

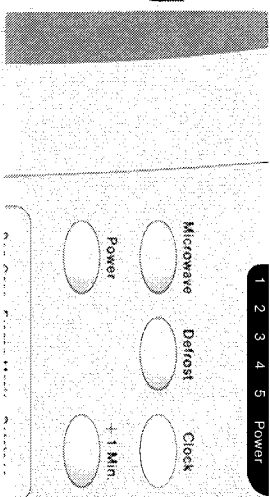
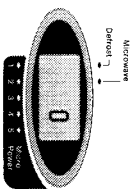
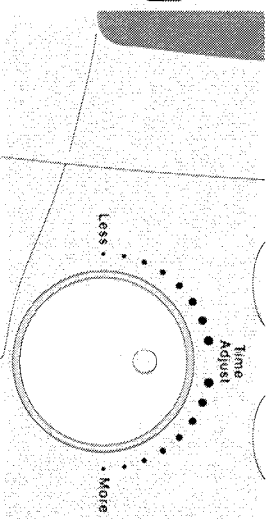
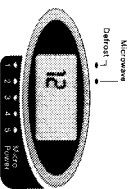
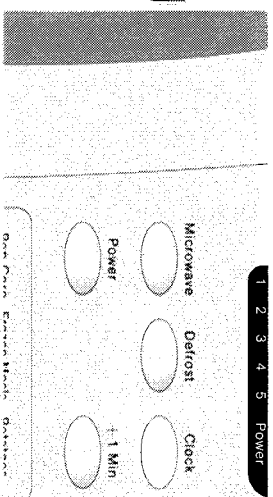
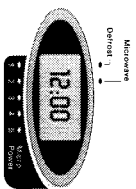

Press the **clock** button for a second time. 0 will flash on the minutes display. Follow step two above to adjust the minutes. When the display shows the right time, press **clock**. Your oven shows the clock whenever it's not being used.

Child lock

To prevent unwanted or accidental use of the oven, the electronic control unit is fitted with two safety devices – start button block and cooking time modification block.

Start button block – press the **stop/clear** button to clear any microwave settings.

Press the **start** button for 5 seconds, you will hear a beep. The **start** button is now disabled and it is not possible to cook with the oven.

Press **stop/clear** (to clear any settings) then the **start** button again for 5 seconds (until you hear a beep) to cancel the start button block function.

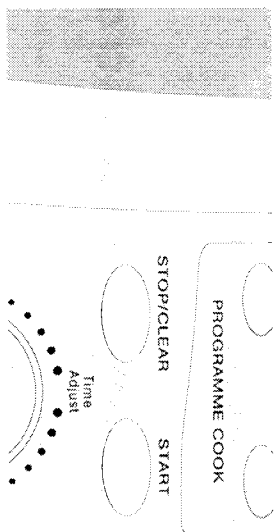

Cooking time modification block – press the **stop/clear** button to clear any microwave settings.

Press the **stop/clear** button for 5 seconds, you will hear a beep. The amount of cooking time set cannot now be altered/tampered with once the **start** button has been pressed and the oven is operating.

Press **stop/clear** (to clear any settings) then the **stop/clear** button again for 5 seconds (until you hear a beep) to cancel the cooking time modification block function.

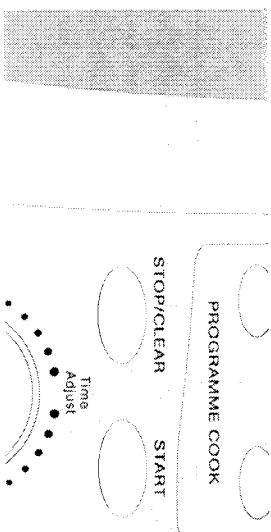

Microwave leakage

If your oven is operated and maintained in accordance with the instructions in this booklet, it should give you many years of trouble free service. It has been tested for safety to the relevant British Standards by a NAMAS approved lab. You should not be at any risk by using it.

You can arrange for your microwave to be checked in future years to ensure that it is continuing to work safely. **You should always have your microwave checked if it is dropped or damaged.**

Introducing microwave cooking

Always remember the basic safeguards you'd follow when using any cooking equipment or handling hot food.

This page gives some of the basic guidelines for microwave cooking.

If you're unfamiliar with using a microwave, there's more information at the back of this guide.

Cooking with a microwave



Cooking with a microwave is much faster than conventional cooking and, whilst you should make sure that food is fully cooked, you should be careful not to overcook it.



If you're cooking a number of individual foods at the same time, such as baked potatoes or small cakes, arrange them evenly on the turntable so that they cook evenly. Never stack food in your microwave.



Meat and poultry which is cooked for 15 minutes or more will brown lightly in it's own fat. Anything cooked for a shorter time can be brushed with a browning sauce to give an appetising colour.



Microwaves can heat unevenly so stirring to distribute heat is very important. Always stir from the outside towards the centre.



Turn larger foods such as meat roasts and poultry during cooking so that the top and bottom cook evenly. It's also a good idea to turn chops and chicken pieces, especially if they contain the bone.



Strips of aluminium foil can be used to cover the thinner pieces of food to stop them overcooking before the thicker parts of the food have had a chance to cook. Use the foil sparingly and wrap around the food or container carefully to stop it touching the inside of the oven which could cause sparks.

Introducing microwave cooking

Microwave ovens cook food using microwaves that are similar to naturally occurring radio waves. Normally, these “waves” would fade as they disappeared into the atmosphere but in a microwave oven they are concentrated onto food causing it to heat up.

Microwave energy can't pass through metal – so they can't escape from inside your microwave oven – but they can pass through materials like glass, porcelain, plastic and paper. These are the things used to make *microwave-safe* cooking equipment.

Microwave-safe cooking equipment will still get hot as the food it contains heats up.

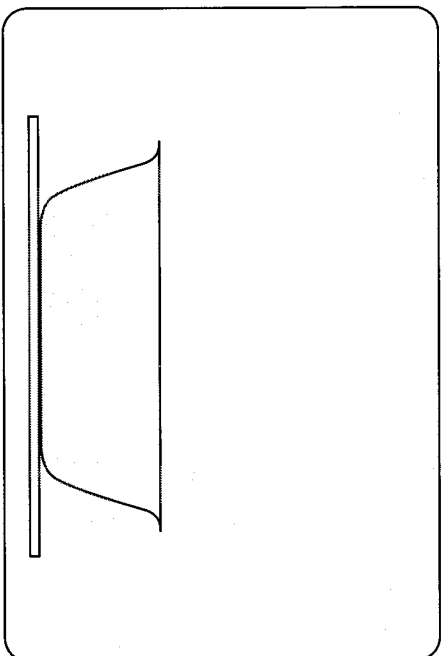

The microwaves focus on the moisture in the food causing lots of tiny vibrations. The vibrations get so great that the moisture – and the food – heat up.

Checking your cooking utensils

Most heat-resistant, non-metallic cooking utensils are safe to use in your microwave. If you're not sure you can use a utensil in your microwave, follow this simple test:

- 1 Put the utensil into the oven next to a cup of water – use a cup that you know is microwave-safe.
- 2 Press the **microwave** button. Set the **time adjust** knob to 30 seconds and press the **start** button. This will microwave the water for 30 seconds.
- 3 At the end of the time, carefully check to see if the water has warmed up. If the water hasn't warmed up but the utensil has, the utensil is not microwave-safe and should not be used in the oven.



Safety

Never use equipment made of metal, except foil, and the spacer rack when you microwave.

The microwave energy can't pass through the metal so they bounce off and spark against the inside of the oven.

Stop the microwave straight away if any equipment does cause sparks.

Remember that some crockery has a metal trim around the edge. Even this trim can cause sparks.



Safety

Never use scratched, cracked or damaged glass in a microwave. Damaged glass can explode.

More about getting the most from microwave cooking

Microwave heating categories

Your oven has been tested and labelled to meet the government's voluntary agreement on the reheating of pre-cooked food.

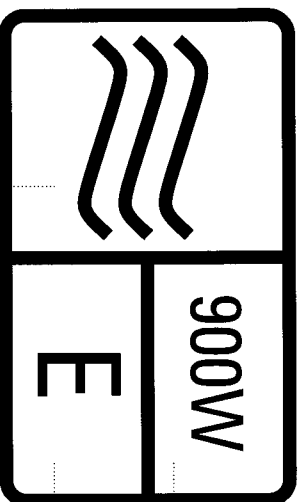

900W is the power of the oven.

E is the cooking band for your oven.

Check the cooking times for band E on the food's packaging to see how long it should be cooked for.

Three wavy lines show that this oven has been tested to meet the agreement.

Remember
Always check that the food is evenly cooked and piping hot before you serve it.

The heating characteristics and output power levels of microwave ovens are usually calculated using a relatively large portion of food (a 1000 gram load, IEC 705) but many packs of pre-cooked food are sold in smaller packs, often about 350 grams. The government, in partnership with food companies and microwave manufacturers, have set up a system of heating categories to help you choose the reheating time for pre-cooked food.

To Microwave: Remove outer packaging. Pierce film lid SEVERAL TIMES. Place on a microwaveable plate. Heat on full power. Turn halfway through heating.

	Heating Category (IEC 705)		Wattage (IEC 705)	
	B	D	650W	750W
Full Power	2	2	2	2
Turn	2	1.5	2	1.5
Standing Time	1	1	1	1
	Minutes	Minutes	Minutes	Minutes

To Microwave from Frozen: Remove outer packaging. Pierce film lid SEVERAL TIMES. Place on a microwaveable plate. Heat on full power. Turn halfway through heating.

	Heating Category (IEC 705)		Wattage (IEC 705)	
	B	D	650W	750W
Full Power	3	2.5	3	2.5
Turn	3	2	3	2
Standing Time	1	1	1	1
	Minutes	Minutes	Minutes	Minutes

Steam

When you microwave food, steam is created as water in the food heats up and evaporates.

The steam formed during microwave cooking is entirely safe. It has to escape from the microwave to prevent pressure from building up inside the oven. It does this through the vents on the back of the oven and from around the door.

Condensation

As the steam cools, you may find the condensation gathers in small pools inside your microwave and on the work surface beneath the door and vents.

Always dry the oven after cooking foods with a high moisture content.

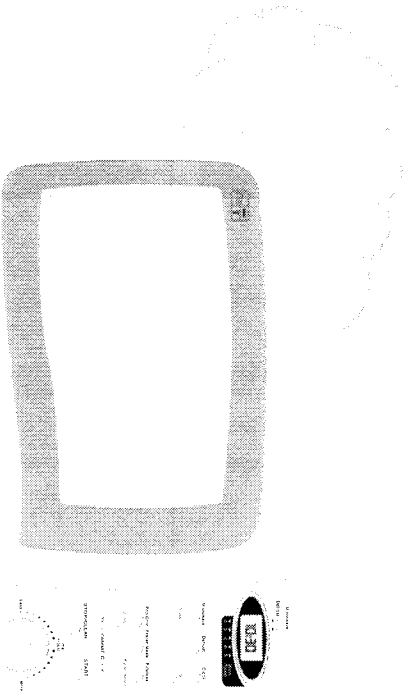

Your microwave is designed to let steam escape from the vents and around the door without microwave energy escaping. There is no danger of microwave energy escaping with the steam.

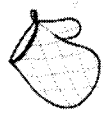

Safety
For your safety, the microwave stops if the oven door is opened during cooking. Press the **start** button to continue the cooking cycle.

Checking your microwave

Check your microwave is working after unpacking and whenever you think it might not be working properly.

Put the turntable ring inside the oven and place the glass turntable on top of the ring. The turntable is shaped to sit securely on the spindle.

You must always use the turntable and ring whenever you use the microwave.

Place a cup of water on the turntable. Make sure the cup is microwave-safe – it shouldn't have any decorative metal trim.

Close the oven door.

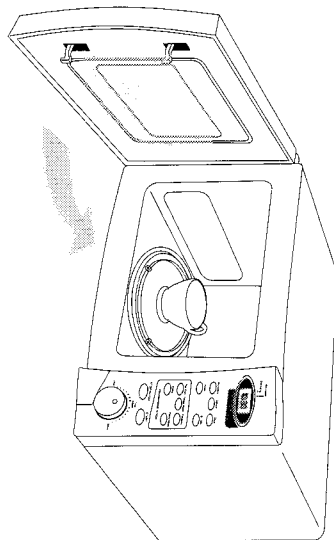

Press the **stop/clear** button to clear any settings that have already been made.

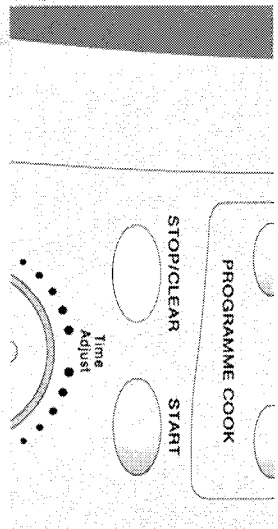

Press the **microwave** button once.

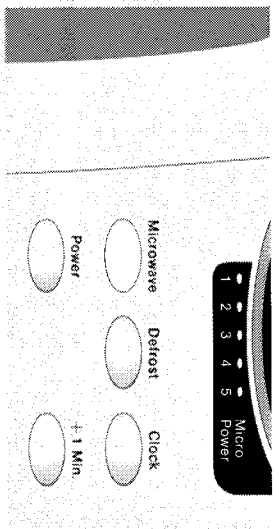

Turn the **time adjust** knob until one minute (1.00) flashes in the display.

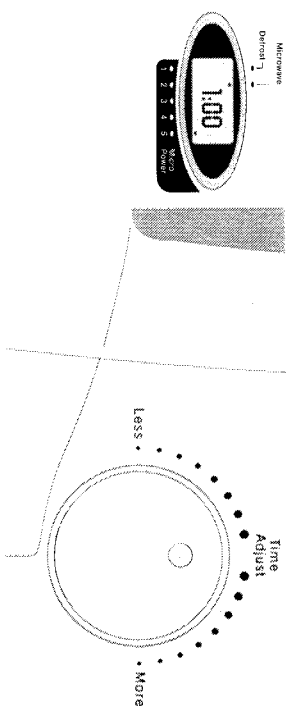

Press the **start** button. The oven light comes on during cooking and the turntable rotates.

At the end of the minute the water should be hot – be careful when you take the cup out of the oven.

When cooking finishes, 3 beeps can be heard and the word *end* will appear on the display.

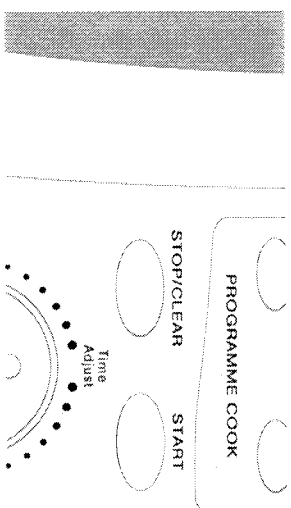

Using the microwave

Basic microwave cooking and reheating

Make sure the glass turntable and turntable ring are inside the oven.

After putting your food in the oven, press **stop/clear** to clear any settings that have already been made.

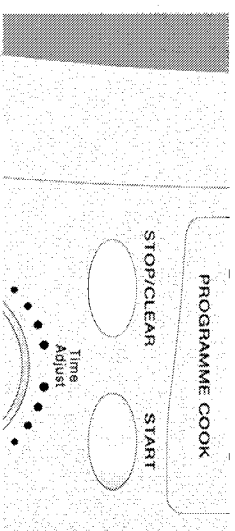

Press the **microwave** button once.

The oven automatically selects **5** – the maximum power level.

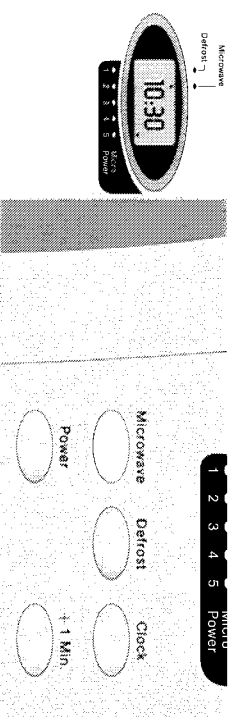

Choose the power level you want to cook on by pressing the **power** button. Each press of the button reduces the power level as shown in the table opposite.

There are five different power levels.

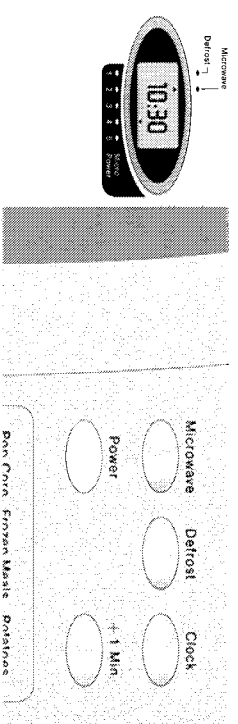

Set the cooking time.

The **time adjust** knob allows you to precisely set the cooking time in 10 second increments up to 3 minutes, in 30 second increments from 3 minutes to 15 minutes, and in 60 second increments from 15 minutes to 59 minutes.

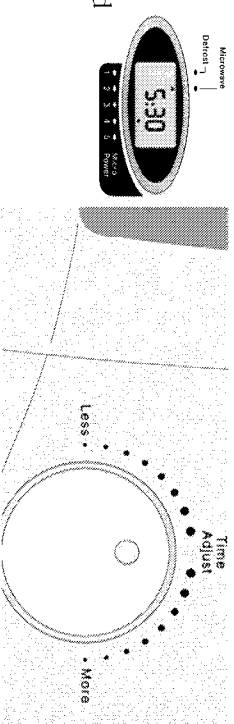

Hint



You can use the **time adjust** knob to alter the cooking time at any time during cooking.

Press start.

The oven light comes on during cooking and the turntable rotates to help the food cook evenly.

You can open the door to check on your food at any time during cooking. If your food is done, press the **stop/clear** button. If the food is not done close the door, and press the **start** button to begin cooking again.

When cooking finishes, 3 beeps can be heard and the word *end* will appear on the display. Open the door and take out the food (the time will appear).

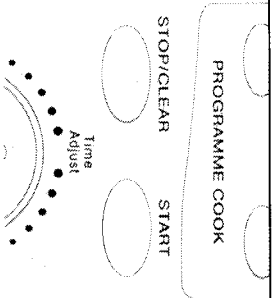

Choosing a suitable power setting

Your microwave has five power settings. Always choose the setting that's best suited to the food you want to cook.

This table shows the power settings.

Power	Output
5	100%
4	75%
3	50%
2	30%
1	15%

Hint

If you do not open the door or press **stop/clear** when *end* is displayed, your microwave power will stop automatically. Press **stop/clear** to return the display to the clock.



Using the microwave

Starting and stopping cooking

It is possible to check the progress of the cooking at any time, by opening the door and inspecting the food. This interrupts the emission of microwaves and the oven stops working until the door is closed again.

Should it be necessary for any reason to suspend the cooking without opening the door, press the **stop/clear** button once (a second press will cancel the set time).

To restart cooking press the **start** button.

Quick start cooking

This function is useful when heating small amounts of food or drink, or for adding an extra minute when cooking time has already elapsed.

Make sure the glass turntable and turntable ring are inside the oven.

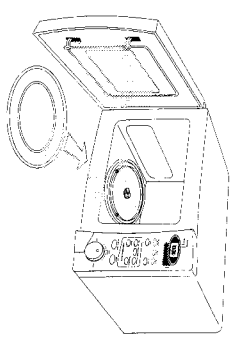

Press the **stop/clear** button to clear any settings that have already been made.

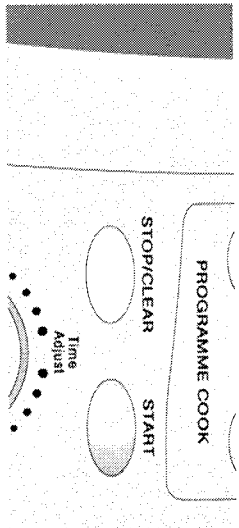

Press the **+1 min** button. The display will flash **1:00** and the microwave indicator will highlight.

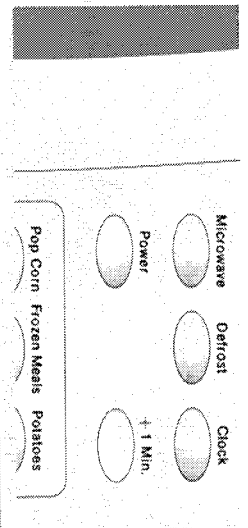
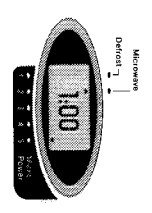

Press the **+1 min** button repeatedly to add further 30 seconds to your cooking time, up to a maximum of 6 minutes.

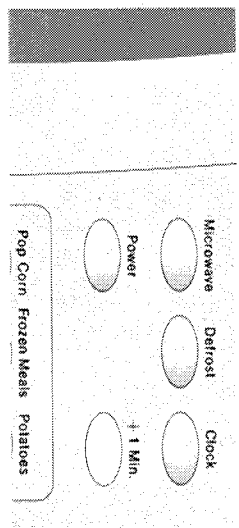
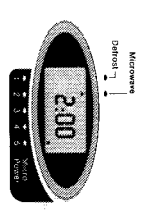

Press Start.

The oven light comes on during cooking and the turntable rotates to help the food cook evenly.

When cooking finishes, 3 beeps can be heard and the word *end* will appear on the display. Open the door and take out the food (the clock will appear).

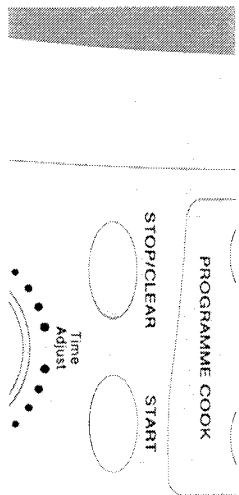

Hint

If you do not open the door or press **stop/clear** when *end* is displayed, your microwave power will stop automatically. Press **stop/clear** to return the display to the clock.



Programme cooking

With programme cooking you don't need to set the power or time – your oven sets them for you.

Press **stop/clear** to clear any settings that have already been made.
 Make sure that any containers you use are ovenproof and will not melt in the oven.

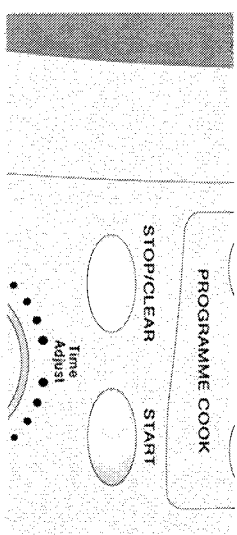

Press the **programme cook** button for the type of food you want to cook. There are five types of instant cook: **drinks, pop corn, frozen meals, potatoes** and **plated meals**.

The table opposite gives advice for cooking the different types of food.

Press your chosen **programme cook** button again to choose the number of servings/length of time you want.
 Each time you press the button the time is adjusted accordingly.

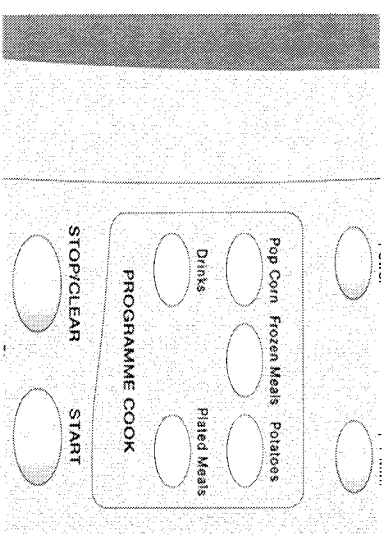

Press **Start**.

The oven light comes on during cooking and the turntable rotates to help the food cook evenly.

When cooking finishes, 3 beeps can be heard and the word *end* will appear on the display. Open the door and take out the food (the clock will appear).

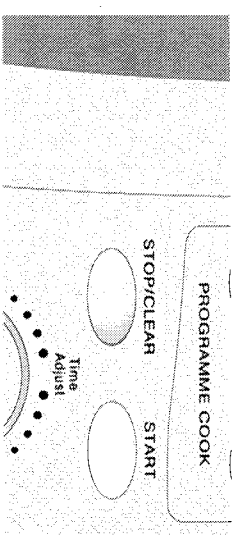

Programme cook type	Presses	What it does	Suggestions
Drinks	1	Reheat 1 small coffee cup (60cc)	After reheating the liquid, stir well to spread the temperature evenly
	2	Reheat 2 small coffee cups (120cc)	
	3	Reheat 1 large cup (200cc) from chilled	
	4	Reheat 1 soup dish (300cc) from chilled	
Potatoes	1	Cook 200g of potatoes	Wash potatoes thoroughly in their jackets, pierce them and put them on the turntable
	2	Cook 400g of potatoes	
	3	Cook 600g of potatoes	
Plated meals (chilled)	1	Reheat 100g of chilled dishes	Suitable for cooked portions of food, preserved in the refrigerator on the plate (the one from which the food is to be eaten). The food must never be covered. For pre-cooked dishes in packets, remove the food from the tubs/packets and place on a plate
	2	Reheat 250g of chilled meat (or meat + vegetables)	
	3	Reheat 250g of chilled pasta or lasagna	
Frozen meals	1	Reheat 1 frozen pizza of 300g	Place the frozen meal directly on the turntable
Pop Corn	1	Cook 100g packet of popcorn for microwaves	Follow instructions written on the box closely and place it on the turntable



Hint

If you do not open the door or press **stop/clear** when end is displayed, your microwave power will stop automatically.

Automatic defrosting

Defrosting with the defrost feature

If you know the weight of the food you need to defrost, you can select the defrosting time using the chart opposite.

Press the **stop/clear** button to clear any settings that have already been made.

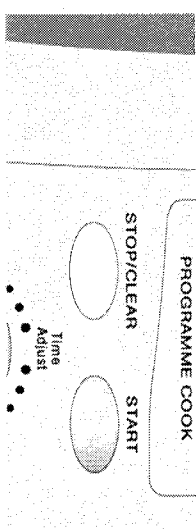

Press the **defrost** button to select auto defrosting.

The display will flash 0.00 and the defrost indicator will highlight.

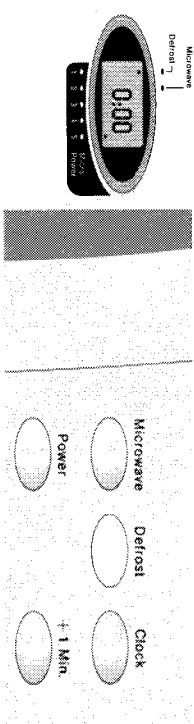

Set the defrosting time.

The **time adjust** knob allows you to precisely set the defrosting time in 10 second increments up to 3 minutes, in 30 second increments from 3 minutes to 15 minutes, and in 60 second increments from 15 minutes to 59 minutes.

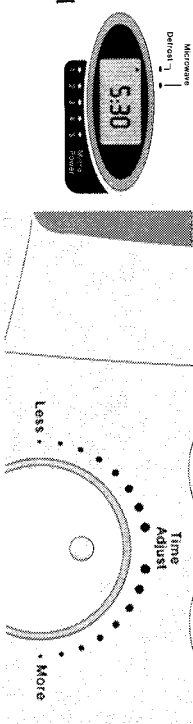

Press the **start** button.

The oven light comes on during cooking and the turntable rotates to help the food defrost evenly.

When defrosting finishes, 3 beeps can be heard and the word *end* will appear on the display. Open the door and take out the food (the clock will appear).

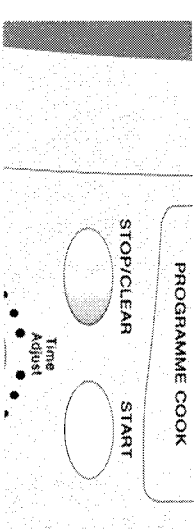

Hint

You can alter the defrosting time with the **time adjust** knob.

Defrost settings

Automatic defrosting

Type of food	Quantity	Defrost time (minutes)	Instructions	Standing time (minutes)
Meat				
Roasts (pork, veal etc.)	1kg	17-22	Turn over halfway through defrosting	20
Steaks, chops	200g	2-6		5
Stew, goulash	500g	9-13		10
Minced	250g	3-7		10
	500g	7-11		15
Hamburgers	200g	3-7		10
Sausages	300g	5-9		10
Poultry				
Duck, turkey	1.5kg	25-28	Turn the poultry over halfway through. When the standing time is over, wash under warm water to remove any ice	20
Whole chicken	1.5kg	25-28		20
Chicken portions	500g	9-13		10
Chicken breast	300g	7-11		10
Vegetables				
			Frozen vegetables are better cooked from frozen and therefore do not require defrosting first.	3
Fish				
Fillets	300g	5-9	Turn the fish over halfway through defrosting	7
Slices	400g	6-10	Fish is better cooked from frozen, if it does not require further preparation	7
Whole	500g	8-12		7
Prawns, shrimps	400g	6-10		7
Milk/Dairy products				
Butter	250g	2-6	Remove the aluminium foil, or the metal parts should not be completely defrosted. Observe the standing time	10
Cheese	250g	3-7		15
Cream	200ml	5-9	Removed from the container and placed in a dish	5
Bread				
2 medium-sized rolls	150g	1-2	Put the bread directly onto the turntable	3
4 medium-sized rolls	300g	2-4		3
Sliced bread	250g	2-4		3
Whole-wheat bread	250g	2-4		3
Fruit				
Strawberries, prunes, cherries				
currants, apricots	500g	8-10	Mix 2 or 3 times	10
Raspberries	300g	5-7		10
Blackberries	250g	3-5		6



Hint

Defrosting can be used in two stage cooking. As food should always be fully defrosted before it's cooked, we recommend that you always check the food before the second stage of cooking starts – especially for meat and poultry.

Automatic defrosting and cooking sequence

Food can be defrosted and cooked without needing to reset your microwave. You may: defrost + cook; cook 1 + cook 2; defrost + cook 1 + cook 2.

Press the **stop/clear** button to clear any settings that have already been made.

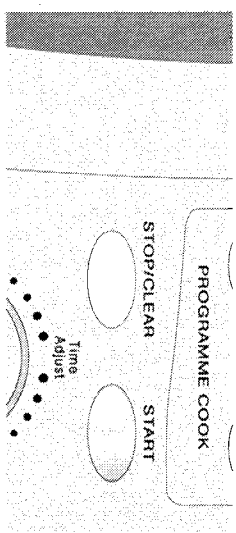

Press the **defrost** button to select auto defrosting. The display with flash **0:00** and the defrost indicator will highlight.

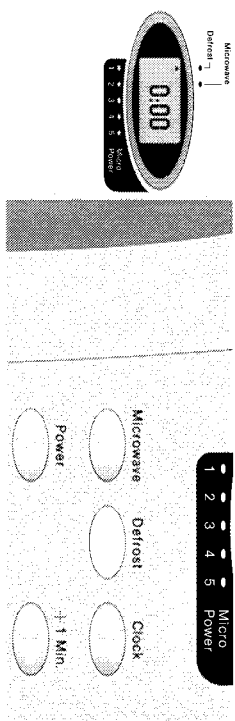

Set the defrosting time.

The **time adjust** knob allows you to precisely set the defrosting time in 10 second increments up to 3 minutes, in 30 second increments from 3 minutes to 15 minutes and in 60 second increments from 15 minutes to 59 minutes.

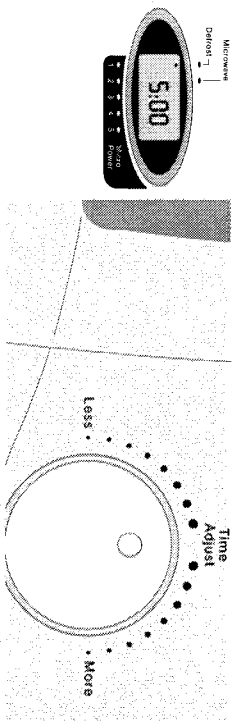

Press the **microwave** button to select microwave cooking.

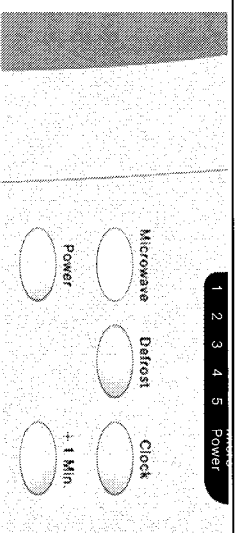

Hint

You can alter the heating time with the **time adjust** knob.



Set the cooking time (**cook 1**).

The **time adjust** knob allows you to precisely set the cooking time in 10 second increments up to 3 minutes, in 30 second increments from 3 minutes to 15 minutes and in 60 second increments from 15 minutes to 59 minutes.

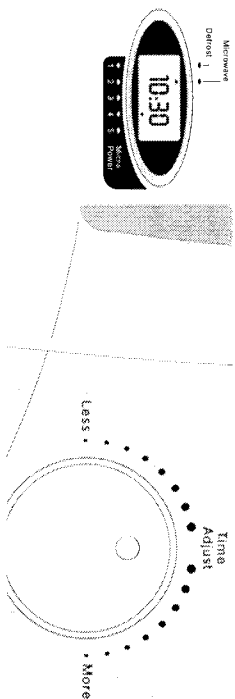

Choose the power level you want to cook on by pressing the **power** button. There are five different power levels.

If you require a second cooking time (cook 2) repeat steps 4, 5 and 6.

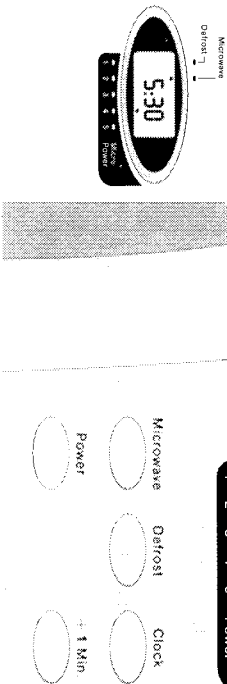

Press the **start** button.

The oven light comes on during cooking and the turntable rotates to help the food defrost/cook evenly.

When cooking finishes, 3 beeps can be heard and the word **end** will appear on the display. Open the door and take out the food (the clock will appear).

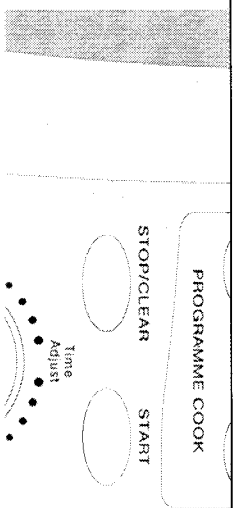

Hint

If you do not specify which power level you require the oven will automatically operate at full power.



Cleaning your microwave

Cleaning your oven each time you use it will help to prevent stubborn marks that can be difficult to clean.

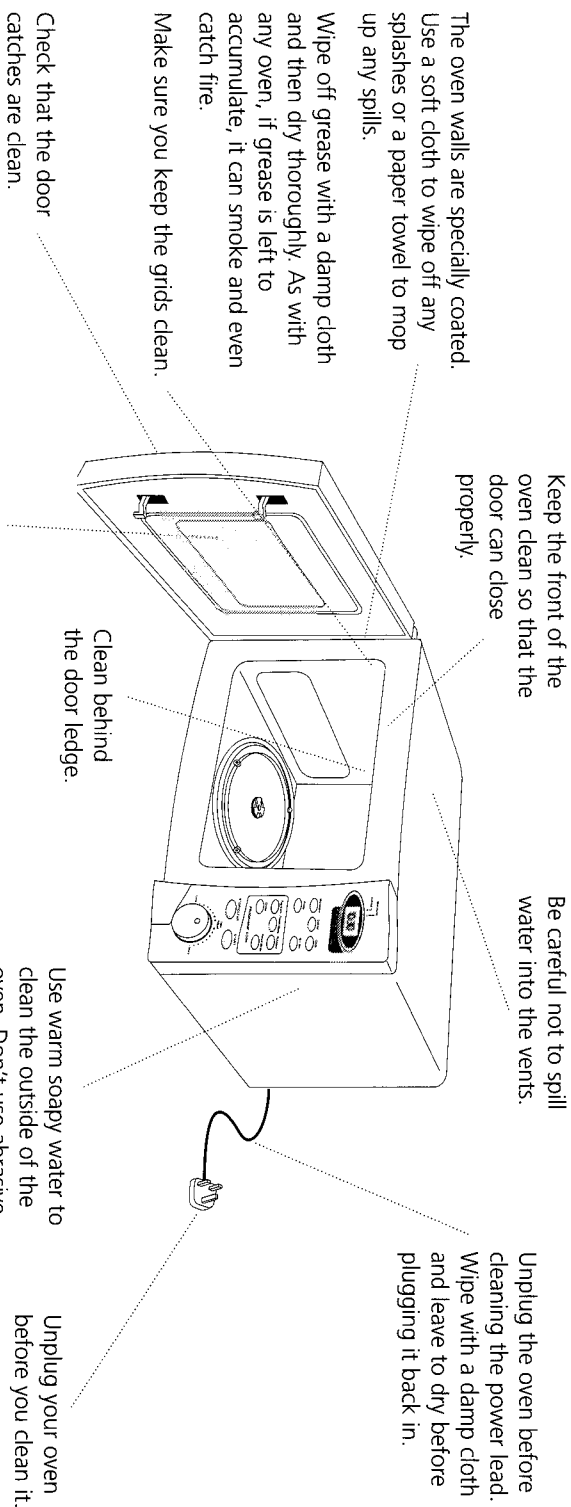

Keep the front of the oven clean so that the door can close properly.

Be careful not to spill water into the vents.

Unplug the oven before cleaning the power lead. Wipe with a damp cloth and leave to dry before plugging it back in.

The oven walls are specially coated. Use a soft cloth to wipe off any splashes or a paper towel to mop up any spills.

Wipe off grease with a damp cloth and then dry thoroughly. As with any oven, if grease is left to accumulate, it can smoke and even catch fire.

Make sure you keep the grids clean.

Check that the door catches are clean.

Clean behind the door ledge.

Keep the inside of the door clean with a damp cloth. Use warm soapy water for stubborn marks and dry thoroughly.

The inside of the door has a special coating and must not be cleaned with abrasive pads or cleaning powders

Do not use alcohol, ammonia-based detergents, abrasive pads or powders to clean the outside of the door.

Use warm soapy water to clean the outside of the oven. Don't use abrasive pads or powders that could scratch the surface.

Unplug your oven before you clean it.

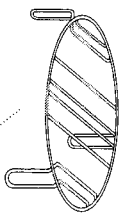

Use warm soapy water to wash the rack and dry thoroughly.

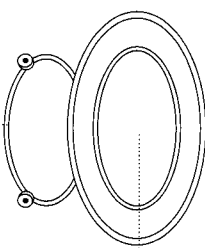

Wash the rotating ring in warm water. Don't use very hot water which could make it warp.

Treat the turntable as you would any glass plate. After you've used it for more than 15 minutes, allow it to cool down before you use it again. Don't wash the turntable in very hot water that could crack it. Make sure the turntable is dry before you put it back in the oven.

Using aluminium foil in your microwave

It's safe to use aluminium foil in your microwave oven as long as you follow these safety guidelines.

As with all metal, microwave energy can't pass through foil, but provided that you keep the foil away from the side of the oven it won't cause sparks and there won't be any damage to your oven.

Using foil is a good way of shielding parts of food that you don't want to cook as quickly as others – perhaps where the food is narrower and would otherwise overcook.

Place the foil over the area you want to shield, taking care that the foil won't touch the sides of the oven when the turntable rotates. Only use one piece of foil at a time so that you don't get sparks between the separate pieces.

Follow these guidelines when using foil in your microwave:

Remove foil lids from containers before using in the microwave. Some lids are made of card with a foil covering – these should be removed too.

Use a microwave-safe transparent lid if possible.

Stir food during cooking if the container has a lid or film cover.

Always use the glass turntable.

Use shallow containers with a large surface area. Do not use containers that are more than 1.25in (3.5cm) deep.

Use oven gloves when handling hot foil containers.

Do not completely cover food with foil. The microwave energy cannot pass through the foil so the food won't cook.

Do not let aluminium foil touch the inside of the oven.

Do not use more than one piece of foil in the oven at the same time.

Foil container bureau

If you have any queries about using foil containers in microwave ovens, you can call the Foil Container Bureau free on 0800 413 295.

Using your oven safely

As with any cooking appliance, make sure that you use your microwave oven safely.

Preparing food for babies

Always be very careful when preparing food and drink for babies and small children.

Avoid scalding by allowing a standing time before testing the temperature of food and drink.

Take extra care when warming milk in baby bottles. Narrow necked bottles can burst if overheated in a microwave oven.

Remove the teat from the baby bottle before using the bottle in a microwave oven. If the teat is left on the bottle, heat can't escape and the bottle could burst.

Safe use of your microwave

Use your microwave for food preparation only.

Never use it for drying cloths, sterilising, or other non-food purposes.

Use containers that are wider at the top than at the bottom.

In microwaves, liquids can heat to above their boiling point without bubbling. When the liquid is lifted out of the oven, the movement can make it boil and bubble up out of the container with the danger of scalding.

Using containers that are wider at the top than at the bottom can help to prevent this from happening.

Only heat popcorn which is labelled for microwave use.

Always stir liquids before, during and after cooking, and allow them to stand before serving.

This gives the liquid an even temperature and helps to prevent it from boiling after it has been taken out of the microwave.

Carefully follow cooking instructions for food with a high sugar or fat content, such as Christmas pudding or fruit cake.

The sugar or fat can overheat and in some cases catch fire. In the event of a fire, switch off the oven and leave the door closed to contain any flames.



First aid

Treat scalding by:

- 1 Quickly placing the scald under cold running water for at least 10 minutes.
- 2 Cover with a clean dry dressing. Do not use creams, oils or lotions.

Fire

In the event of fire:

- 1 Keep the oven door closed.
- 2 Turn off the power.
- 3 Unplug from mains.



Never use the oven when it is empty.

It's a good idea to leave a cup of water inside the oven at all times in case someone should accidentally switch it on.

Do not heat oil or fat for deep frying. The oil could overheat and catch fire.

Do not leave a conventional meat thermometer in food during cooking. Remove the food from the oven before testing the temperature and remember to remove the thermometer before you put the food back in the microwave.

Do not use metal objects in the microwave.

These include:

- metal cooking utensils
- metal plates or trays
- wire twist ties
- crockery with metal trims.

Never leave the oven unattended during use.

Cooking times given in recipes should be used as a guide only. The weight, shape and starting temperature of the food will all affect the time actually needed for cooking.

Check the food during cooking. If you're not sure whether the food is cooked, check it with a fork.

Cooking for too long could cause smoking or even fire.

Do not use capped bottles, vacuum-tight containers or sealed jars in the microwave.

Do not cook eggs or nuts in their shells.

Pierce the skin of fruit and vegetables, such as apples or potatoes, and egg yolks before cooking.

Pressure builds up inside sealed containers, and inside foods with a shell or skin as they heat. This can cause the container or food to explode.

Be careful when using paper, plastic, wooden or other combustible materials in the oven as they can catch fire.

Only use paper towels if your cookery book instructs you to.

Leave repairs and maintenance to trained repairers.

Never tamper with or adjust: the door; the control panel; the power cable; the door catches.

Be careful not to catch paper towels or other objects between the door and the oven when you close the door.

Microwave energy can escape if the door is not closed properly.

If you wear a pacemaker, consult your doctor before using a microwave.

Questions and answers

Why doesn't food seem to cook?

Check that:

- the cooking time has been set
- the door is closed
- the power socket is not overloaded causing a fuse to blow.

Why is it so important that I allow standing time after cooking?

With microwave cooking, many foods build up enough heat inside them to continue cooking even after they've been taken out of the oven. Because microwave cooking works from the outside of food inwards, standing time lets you cook the centre of the food just right without the outside being overcooked.

Why does the food seem undercooked or overcooked?

Check that:

- the correct cooking time has been set
- the correct power setting has been used.

Why does my oven sometimes take longer to cook than it says in the recipe?

First check that the oven was set just as the recipe said.

Cooking times and heat settings are suggestions to help prevent overcooking but differences in the weight, size, shape and starting temperature of food will all affect how long it takes to cook – just as it does with a conventional oven.

Use your judgement along with the recipe to check whether food has been cooked properly.

How can I stop eggs from popping?

When you bake or poach eggs in the microwave, the yolk can sometimes pop as steam builds up inside it. You can stop the egg from popping by piercing the yolk with a toothpick before cooking.

Never cook eggs that are still in their shells.

Why do I get condensation on the inside of the oven door?

Condensation is perfectly normal, especially when you're cooking food with a high moisture content such as potatoes.

Does the microwave energy get through the window on the door?

No. The door has a special metal screen with holes in that lets you see inside but stops microwave energy from getting out.

Steam comes out of the side of the door and vents. Can microwave energy get out too?

No. The door and vents are carefully designed to let steam out during cooking but keep microwave energy in. The gaps are not big enough for microwave energy to escape.

What happens if the microwave is switched on while the oven is empty?

The microwave will be damaged. Don't switch the microwave on when there's nothing inside the oven. It's a good idea to keep a cup of water in the oven just in case someone accidentally starts the microwave.

Why won't the oven light come on?

Open the door. If the light doesn't come on, the bulb has probably blown. Call a qualified repairer – don't try to change the bulb yourself.

There are sparks inside the oven when I use the microwave. Will this cause any damage?

Yes. Make sure that you are not using any metal utensils and that your containers don't have a metal trim. You must not use metal in your microwave, except foil, when you cook.

Light is showing through the vents and door. Does this mean the microwave energy can escape?

No. It's normal for the light to be visible and is nothing to be concerned about.

Why do I get interference on my TV and radio when I use the microwave?

Microwave ovens use radio waves similar to those received by TVs and radios. You can lessen the interference by moving your microwave further away from the TV or radio.

Cooking guidelines

Always make sure that meat is fully cooked before serving.

- ## Microwave cooking
- Use the cooking times and food quantities as a guide.
The more food you are cooking, the longer you should cook it for.
 - Cook in microwave-safe containers.
 - Check that the oven is cool before using plastic containers – especially if you've just been using the grill or convection oven.
 - If you use cling film to cover your food, turn back a corner or pierce the film before you begin to cook.

Meat

Place the meat on a microwave roasting rack or microwave-proof plate.

Put the rack into the oven on the glass turntable and follow the cooking instructions.

Halfway through cooking, turn the meat over to allow both sides to cook.

At the end of the cooking time, cover the meat and leave it to stand for about 5 to 10 minutes.

Standing time allows the centre of the meat to continue to finish cooking without overcooking the outside.



Hint

Remember that size and shape effect cooking time. Larger portions take longer than smaller portions and larger cuts take longer than smaller ones.

Vegetables

Microwave cooking is ideal for vegetables – flavours are more distinct, colours are brighter and more nutrients are retained.

Prepare your vegetables as normal. Try to cut them to roughly equal sizes and spread them out in the dish so that they all cook evenly. Arrange whole or halved vegetables, such as potatoes, in a circle with centre open. Keep as much space as possible between each vegetable. Pierce any vegetables that have a skin. Place tender vegetables, such as asparagus or broccoli, with the more tender parts towards the centre.

Add the minimum of water, about 2–4 tbsp is normally enough. Some vegetables will cook in their own moisture. Add salt according to taste.

Cover the dish with a lid or microwave cling film (always pierce the film to let steam escape). Place the dish onto the glass turntable.

Shake or stir during cooking.

Leave the vegetables covered for the full standing time. Standing time allows the centre of the vegetables to continue to cook without overcooking the outside.

Poultry

Remove the giblets and any metal clamps, and prepare the poultry as you would normally. Always make sure that poultry is fully defrosted before you start to cook.

Prick the skin and lightly brush with vegetable oil.

You don't need to use any oil if it is a self-basting bird.

Cooking guidelines Microwave cooking



Hint

Remember that size and shape effect cooking time. Larger portions take longer than smaller portions and larger vegetables take longer than smaller vegetables.



Safety

Be careful when you uncover cooked vegetables as steam burns.

Cooking guidelines Microwave cooking

Always make sure that poultry is fully cooked before serving. Pierce the thickest part of the meat with a sharp knife. If the juice runs clear and the meat is firm, the meat is cooked.



Hint

Remember that size and shape effect cooking time. Larger portions take longer than smaller portions and larger cuts take longer than smaller ones.

Place the meat on a microwave roasting rack or microwave-proof plate.

Put the rack into the oven on the glass turntable and follow the cooking instructions.

Use the weight of the bird when stuffed to calculate the cooking time.

Turn the meat halfway through the cooking time to allow both sides to cook evenly.

If you don't turn it, poultry can cook unevenly because of its irregular shape.

At the end of the cooking time, cover the meat and leave it to stand for about 5 to 10 minutes.

Standing time allows the centre of the meat to finish cooking without overcooking the outside.

Soups and rice

Soups or broth usually require a small amount of liquid because the evaporation in microwave ovens is rather limited. Because it is a dehydrating agent, salt must be added only when the cooking is finished or during the standing time.

The temperature required for cooking rice (or pasta) in a microwave oven is more or less the same as that needed to cook it on a regular hob. The advantage of preparing a risotto dish in a microwave oven is you do not have to stir the rice constantly (two or three times is enough).

Make sure the ingredients are placed in a container suitable for microwave ovens and covered with clear sheet (for about 300 gr. of rice, you need 750 gr. of broth with the oven programmed at 5 for about 12 to 15 minutes).

Baked goods and fruit

Baked goods rise more at lower oven power in your microwave than in a conventional oven. Since no crust is formed, it is better to garnish the surface portions with cream or icing after cooking. In addition, you must keep items being baked fully covered, because they tend to dry out.

Fruit is to be pierced, if cooked with its peel on, and is to be kept covered. It is essential that you stick to the standing time (3 to 5 minutes).

In order to obtain uniformly risen baked goods and to guarantee excellent results place a bowl (about 4cm high) over your baking dish (ideally a Pyrex pie plate) and place them in the middle of the turntable.

Microwave cooking chart

Food	Quantity	Settings	Cooking time (minutes)	Instructions	Standing time (minutes)
Beef (Roast)	Rare	4	4-5	Turn at the halfway point. Wrap in foil and stand	15-20
	Medium	4	5-6		15-20
	Well done	4	6-7		15-20
	Beefburgers	4	5		
Pork	Roast joint	4	6-7	Turn at the halfway point. Wrap in foil and stand	15-20
	Baked ham	4	7		15-20
	Bacon rashers	2	1.5		
	Bacon rashers	4	2		
Bacon rashers	6	5	3.5		
Lamb	Roast	4	6-7	Turn at the halfway point. Wrap in foil and stand	15-20
Poultry	Whole chicken	4	8-10	Start cooking breast side down and turn halfway. Wrap in foil and stand	15-20
	Duck	4	8-10		15-20
	Turkey	4	8-10		15-20

Microwave cooking chart (continued)

Food	Quantity	Settings	Cooking time (minutes)	Instructions	Standing time (minutes)
Fish	Filleted	5	3-5	Lay in dish with thickest part outwards, brush with melted butter or lemon juice, cover to cook.	5-10
	Steaks	5	2-5	cover to cook.	5-10
	Flat fish	5	1-5	leave to stand for 3 mins. Slit skins to prevent bursting. Shield head and tail with foil cover.	5-10
	Whole	5	2-5		5-10
	Whole +	4	5		5-10
Vegetables	Asparagus	5	3-5	Cut in to 2 cm pieces and cover	4
	Green beans	5	8-10	Cut into pieces and cover	4
	Broccoli	5	5-7	Separate into individual florets	4
	Brussels sprouts	5	6-7	Leave whole and cover	4
	White cabbage	5	6-7	Cut into strips and cover	4
	Red cabbage	5	6-7	Cut into strips and cover	4
	Carrots	5	6-7	Cut into same-size pieces and cover	4
	Cauliflower	5	6-7	Separate into stalks and cover	4
	Celery	5	5-6	Separate into pieces and cover	4
	Leek	5	5-6	Cut into strips and cover	4
	Mushrooms	5	3-5	Leave whole and cover. No water	4
	Onions	5	5-7	Whole, but same size. No water	4
	Spinach	5	3-4	Cover after washing leaves	4
	Peas	5	3-4	Cover	4
	Baked potatoes	5	2-3	Leave to stand	5-10
	Baked potatoes	5	2-3	Leave to stand	5-10
	Baked potatoes	5	3-4	Leave to stand	5-10
	Baked potatoes	5	4-5	Leave to stand	5-10
	New potatoes	5	4-5	Cut into same-size pieces and cover	4
	Old potatoes	5	5-6	Cut into same-size pieces and cover	4
	Courgette	5	7-9	Cut into slices and cover	4
	Cakes	Nut cake	3	13-17	
Viennese torte		3	17-21		5
Pineapple cake		3	15-19	Mix pineapple pieces	5
Apple cake		3	17-21		5
Coffee cake		3	13-17		5
Zabaione	4	1-5-3	Mix with a whisk every 30 seconds	3	
Fruit	Cooked pears	5	3-5	Cut into quarters	3
	Cooked apples	5	4-6	Cut into quarters	3

Microwave reheating chart

- We recommend that you heat foodstuffs to a temperature of at least 70° C – the food must be piping hot.

Cooking guidelines
Microwave reheating

Food	Quantity	Settings	Time (minutes)	Instructions
Softening Food				
Chocolate	100g	3	4-5	Put in a dish. No need to stir
Iceing	100g	3	3-4	Put in a dish, stir once
Butter	50-70g	5	5-10 seconds	Put in a dish. No need to stir
Chilled food (initial temperature of 5/8°C up to approximate 20/30°C)				
Yoghurt	125g	5	10-15 seconds	Remove any metal tops
Baby feeding bottle	240ml	5	20-30 seconds	Reheat without the teat, and shake before use. Milk at room temperature takes a shorter time. Mixed dried milk should be stirred thoroughly. Check the temperature before use.
Chilled precooked foods (initial temperature 5/8°C up to approximate 70°C)				
Lasagna or stuffed pasta	400g	5	4-6	For foods to be heated to a temperature of 70°C, remove from foil packaging and put onto plate from which it is to be eaten. Cover with film or an upturned plate
Meat with rice and/or veg.	400g	5	4-6	
Fish and/or veg.	300g	5	3-5	
Plate of meat and/or veg.	400g	5	5-7	
Plate of cannelloni or lasagna	400g	5	5-7	
Plate of fish and/or rice	300g	5	4-6	
Frozen foods (initial temperature -18/-20°C up to approximate 70°C)				
Lasagna or stuffed pasta	400g	5	6-8	For precooked frozen foods to be heated to a temperature of 70°C, remove from foil packaging and put onto plate from which it is to be eaten. Cover with film or an upturned plate Place any raw food in a microwave container and cover
Meat with rice and/or veg.	400g	5	5-7	
Fish and/or precooked veg.	300g	5	3-5	
Fish and/or raw veg.	300g	5	8-10	
Portion of meat and/or veg.	400g	5	6-8	
Portion of cannelloni or lasagna	400g	5	7-9	
Portion of fish and/or rice	300g	5	4-6	
Chilled drinks (initial temperature 5/8°C up to approximate 70°C)				
1 cup of water	180cc	5	2-2.5	Stir after reheating to distribute heat evenly
1 cup of milk	150cc	5	1.5-2	Stir after reheating to distribute heat evenly
1 cup of coffee	100cc	5	1.5-2	Stir after reheating to distribute heat evenly
1 bowl of broth	1 portion	5	4-5	Cover the soup with an upturned plate
Drinks at room temperature (initial temperature 20/30°C up to approximate 70°C)				
1 cup of water	180cc	5	1.5-2	Stir after reheating to distribute heat evenly
1 cup of milk	150cc	5	1-1.5	Stir after reheating to distribute heat evenly
1 cup of coffee	100cc	5	1-1.5	Stir after reheating to distribute heat evenly
1 bowl of broth	300cc	5	3-4	Cover the soup with an upturned plate

Cooking on two levels

Cooking on two levels enables you to cook an entire meal in one go.

By using the spacer rack you can defrost, reheat and cook two different dishes at the same time. The special double-microwave-emmission system makes this possible.

When you wish to cook two food dishes at the same time, all you have to do is keep these basic rules in mind:

- the cooking times for food dishes cooked at the same time are different from those for the cooking of single dishes. So always consult the reference table.
- Be careful to always place on the spacer rack the food that requires less cooking time, it will be easier to remove the upper pan. Take the rack out and finish cooking the food underneath.
- Pay attention to the indications and recommendation in the table opposite. In particular, always check to be sure that the food being reheated is very hot before removing it from the oven.

Cooking on two levels chart

Process	Type	Pan position	Quantity	Power	Time (minutes)	Notes	
Defrost	Ground meat	above	500g	defrost	20	Turn over after 15 minutes. Stand for a further 15 minutes.	
	Ground meat	below	500g	defrost	20		
	Chicken pieces	above	500g	defrost	24	Pull meat apart during defrosting.	
	Stew	below	500g	defrost	24	Stand for a further 15 minutes	
	Cauliflower	above	450g	defrost	22	Stand for 5 to 10 minutes	
	Whole fish	below	500g	defrost	22	Stand for 5 to 10 minutes	
	Reheat	Meat, single	above	150g	5	6	Cover the food with plastic wrap
		Vegetables, single	below	250g	5	6	As above
		Plate of lasagna	above	500g	5	9	As above
		Plate of lasagna	below	500g	5	9	As above
Meat single		above	150g	5	6	As above	
Plate of lasagna		below	500g	5	8	As above	
Cooking		Potatoes	above	500g	5	10	Cut into pieces and cover with wrap
		Potatoes	below	500g	5	10	Cut into pieces and cover with wrap
		Carrots	above	500g	5	8	Cut into pieces and cover with wrap
		Carrots	below	500g	5	8	Cut into pieces and cover with wrap
	Sliced fish	above	400g	5	11	Cover the food with plastic wrap	
	Courgettes	below	475g	5	13	Leave whole and cover with wrap	
	Whole fish	above	200g	5	7	Cover the food with plastic wrap	
	Courgettes	below	475g	5	12	Leave whole and cover with wrap	
	Whole fish	above	200g	5	7	Cover the food with plastic wrap	
	Whole fish	below	200g	5	7	Cover the food with plastic wrap	
Cooking	Potatoes	above	500g	5	10	Cut into pieces and cover with wrap	
	Goulash	below	1.5kg	5	38	After 24 mins remove wire rack	
	Rice	above	300g	5	22	Cover with plastic wrap and stir twice	
	Cabbage	below	500g	5	22	Leave whole and cover with wrap	
	Peas	above	500g	5	9	Cover the food with plastic wrap	
	Brussels sprouts	below	500g	5	9	Cover the food with plastic wrap	
	Meatloaf	above	500g	5	23	Turn over at 15 minutes	
	Potatoes	below	500g	5	10	Cover with plastic wrap	
	Sausages	above	300g	5	11	As above	
	Sausages	below	300g	5	11	As above	
Cooking	Stew	above	700g	5	28	As above	
	Pork roast	below	700g	5	28	Turn over at 18 minutes	

Cooking guidelines Cooking on two levels



Hint

Pay strict attention to the times set out in this table. If in doubt, check that the food being reheated is very hot before removing it from the oven.

Microwave defrosting

For a defrosting chart see page 15

- Foods frozen in bags or plastic sheeting or in their packaging may be placed directly in the oven, as long as they have no metal parts (e.g., bands or closure rivets).
- Certain foods, such as greens, vegetables and fish, do not have to be completely defrosted before you begin cooking them.
- Stewed foods and meats as well as meat sauces defrost better and quicker if they are stirred from time to time, turned over or separated.
- While defrosting, meat and fish lose their liquid content. It is recommended, therefore, that you defrost such items in a tray or basin.
- It is advisable to separate each individual piece of meat from its bag before putting it in the freezer. This will help you save valuable time will preparing foods.
- Be careful about following the cooking times printed on frozen products, because those times are not always correct. It is best to use defrosting times slightly less than those indicated. The time needed for defrosting will vary in terms of the degree to which the food has been frozen.

Specification

Electrical Supply

Specification

Input	230-240V AC, 50Hz
Output	900 Watts (IEC 705 rating standard – 1988 measured at 240V)
Microwave frequency	2450MHz
Outside dimensions	520mm wide x 305mm high x 400mm deep
Oven cavity dimensions	322mm wide x 218mm high x 331mm deep
Power consumption	1400W
Oven Light	25W
Turntable diameter	31cm
Approx. weight	17kg approx
Gross weight	18,3kg approx

Complies with EEC directive 89/336 and 92/31 relating to Electromagnetic Compatibility.

Dimensions shown are approximate.

Because we continually strive to improve our products, we may change specifications without prior notice.

WARNING: This appliance must be earthed.

Fuses

Your appliance comes fitted with a plug and a 13A fuse. If you need to replace the fuse, only those rated at 13A and ASTA approved to BS1362 should be used.

Changing the Plug

Cut off and dispose of the supplied plug if it does not fit your socket.

WARNING: To avoid a shock hazard do not insert the discarded plug into a socket anywhere else.

IMPORTANT: WIRES IN THE MAINS LEAD ARE COLOURED IN ACCORDANCE WITH THE FOLLOWING CODE:

Green/Yellow Earth
Blue Neutral
Brown Live

If you change the plug, the colour of wires in the mains lead may not correspond with the colour of the markings identifying terminals in the plug. You should therefore wire it as shown.

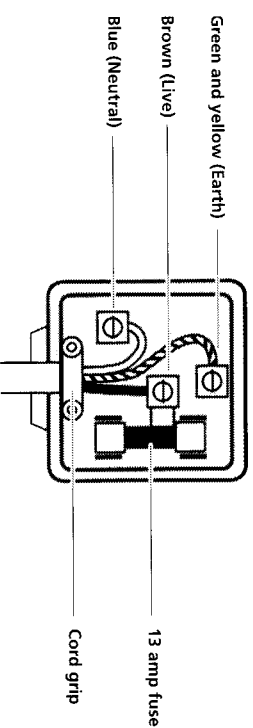

Changing the Mains Lead

A special lead can be ordered from Hotpoint Service UK: 08709 066 066 or Republic of Ireland: 1850 302 200

If you have damaged the existing lead or require a longer one a charge will be made. It is strongly advised that this work is carried out by a qualified electrician.

CE CE marking certifies that this appliance conforms to the following EEC directives:

Low Voltage Equipment – 72/23/EEC & 93/68 EEC
Electromagnetic Compatibility – 89/336/EEC & 92/31 EEC & 93/68/EEC

Hotpoint Service

Satisfaction Guaranteed or Your Money Back

Hotpoint gives you a unique 'Satisfaction Guaranteed' promise – valid for ninety days after you have purchased your Hotpoint product. If there is a technical problem with your Hotpoint appliance, call Hotpoint Service. If necessary we will arrange for an engineer to call. If the technical problem is not resolved under this Guarantee, Hotpoint will replace your appliance or, if you prefer, give you your money back.

Hotpoint After Sales Service

Hotpoint appliances carry for the first 12 months a fully inclusive parts and labour guarantee. When the 12 months parts and labour guarantee expires we offer two after sale service options:

Repair Service

UK: 08709 066 066 or Republic of Ireland: 1850 302 200

All repairs carry a fully inclusive parts and labour guarantee for 12 months from the date of the repair.

Note: Chargeable service is offered on the basis of payment on completion to our Service Engineer, who will issue a receipt.

Extended Warranties

UK 08709 088 088 or Republic of Ireland: 1850 502 200

Whether you have just one or a number of Hotpoint appliances in your kitchen, Hotpoint offer two Service Cover Plans to give you complete peace of mind. They enable you to extend your first 12 months labour guarantee by either 1 or 4 years, so that you can have FREE repairs during the membership period.

Service Cover. FREE service repairs during the period of cover. At an additional cost Service Cover

with Maintenance includes an Annual Electrical and Safety check along with replacement of any parts necessary.

Kitchen Cover. An annual payment covers repairs for all your Hotpoint appliances which are less than ten years old. Additional Hotpoint appliances purchased after you have joined Hotpoint Kitchen Cover are automatically included during the annual period of cover without further charge.

Easy Payment Methods

We offer a number of payment methods; cheque, credit card or you can spread the cost and pay by direct debit. For further details telephone: 08709 088 088

Appliance Registration

To benefit from the above options, complete and return the Appliance Registration Form/Questionnaire supplied with this appliance. Full details and costs of our service options together with an application form, will then be sent to you at the end of the 12 month guarantee period.

Hotpoint Genuine Parts & Accessories

A wide range of parts and accessories are available from Hotpoint Genuine Parts & Accessories Mail Order Hotline UK 08709 077 077 or Republic Of Ireland: 01 842 6836

Key Contacts

Service

UK: 08709 066 066

Republic of Ireland: 1850 302 200

You will be asked to quote the Model Number and Serial Number, which can be found on the inside of the door.

Hotpoint Guarantee

From the moment your appliance is delivered, Hotpoint guarantees it for 12 months.

- Hotpoint appliances carry a fully inclusive 12 months parts and labour guarantee.

- All Hotpoint servicing is carried out by our own Service Organisation located throughout the United Kingdom and Republic of Ireland. We will be happy to deal with any problems which you may have.

Our Engineers will use every effort to avoid damage to floor coverings and adjacent units when carrying out repairs/service work, but in locations where the Engineer advises you that it will be impossible to move appliances without risk of damage, he will only proceed with your approval that no liability is accepted.

Guarantee Terms & Conditions

Your Guarantee is only applicable in the United Kingdom or Republic of Ireland and is subject to provision(s) that your appliance:

- Has been used solely for domestic purposes and is on domestic premises i.e. not for commercial or trade use.
- Has been used solely in accordance with this instruction book.
- Has been properly connected to a suitable electrical supply voltage as stated on the appliance rating plate.
- Has not been subject to misuse, accident, modified or repaired by anyone other than our own Service Engineers.

Service

UK: 08709 066 066

Republic of Ireland: 1850 302 200

You will be asked to quote the Model Number and Serial Number, which can be found on the inside of the door.

Genuine Parts & Accessories Mail Order Hotline

UK: 08709 077 077

Republic of Ireland: (01) 842 6836

Extended Warranty

To join: UK 08709 088 088

Republic of Ireland: 1850 502 200

For further product information

0541 50 60 70

All Hotpoint Services are offered as an extra benefit and do not affect your statutory rights.
Applicable to UK only.

Hotpoint

General Domestic Appliances Limited, Morley Way, Peterborough, PE2 9JB.

No part of this publication may be reproduced, stored in any retrieval system or transmitted, in any form or by any means, without the prior permission in writing of the Manufacturer, nor be otherwise circulated in any form of binding or cover other than that in which it is published and without a similar condition including this condition being imposed on the subsequent purchaser.